

# Bulletin nr. 1

## NM for par 1996, Junior

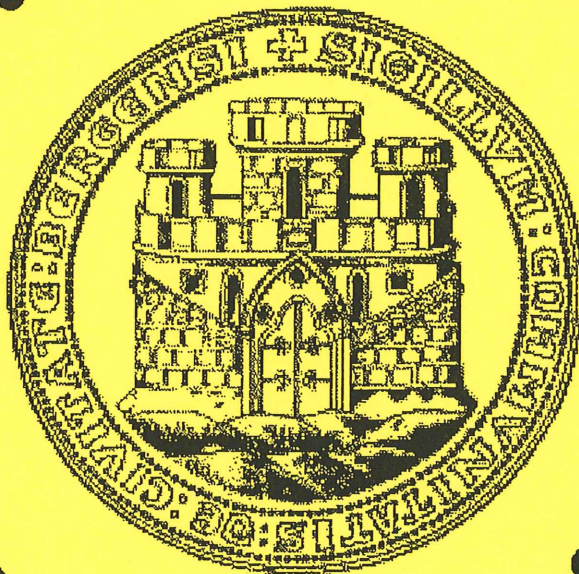

Fjorårmestrene og favorittene, Boye Brogeland - Øyvind Saur, har gått til tet. Det eneste paret som så noenlunde har holdt følge er et annet par fra Bergenskanten: Roger Træet - Frode Fyllingen.



N M   f o r   p a r ,   J u n i o r  
1 9 9 6

STILLINGEN ETTER 7. RUNDE

1.	16	Boye Brogeland - Øyvind Saur.....	Bergen.....	83	9ØV
2.	18	Roger Træet - Frode Fyllingen.....	Haugaland/Bergen.....	68	11NS
3.	7	Ole Marius Myrvold - Odin Svendsen.....	Oslo.....	34	2NS
4.	4	Thomas Herstad - Tormod Daling.....	Inntrøndelag/Trondh..	27	5NS
5.	6	Hege Sørlie - Joar Haugseth.....	Hedemarken.....	24	3NS
6.	1	Lasse M. Sylten - Stig Roar Hakkebo.....	Namdal.....	17	8ØV
7.	19	Ove Andersbakken - Magne H. Forberg.....	Nord-Gudbrandsdal....	12	12NS
8.	10	Tore Skoglund - Jan Einar Sæthre.....	Sør Østerdal.....	9	3ØV
	22	Atle Sæterdal - Svein Chr. Johannessen..	Bergen.....	9	10NS
10.	21	Tommy Elde - Lemet Ivar Hætta.....	Vest-Finnmark.....	7	11ØV
11.	8	Roger Asbjørnsen - Tor Saur.....	Buskerud.....	6	1ØV
12.	12	Roger Ottesen - Bjørn-Harald Jensen.....	Vest-Finnmark.....	1	5ØV
13.	23	Arild Holdaas - Kjetil Hildal.....	Fosen/Trondheim.....	0	9NS
14.	3	Vegard Brekke - Geir Abel Ellingsen.....	Midt-Telemark/Oslo...	-5	6ØV
	15	Stian Sundklakk - Trond Kirkesjord.....	Troms og Ofoten.....	-5	8NS
16.	5	Ulf Sverdrup - Sølvi Beate Østmo.....	Oslo.....	-6	4NS
17.	13	Thomas Charlsen - Espen Erichsen.....	Bergen.....	-19	6NS
18.	2	Jonn S. Granhaug - Harald Rygg Hjorten..	Helgeland.....	-21	7NS
19.	20	Bjørn Grue - Trond Nygjelten.....	Nord-Østerdal.....	-23	12ØV
20.	14	Odd Egil Skodje - Tommy Skodje.....	Sunnmøre & Romsdal...	-28	7ØV
21.	17	Hans E. Skjæggerud - Øystein Ree.....	Salten.....	-40	10ØV
22.	11	Bjørn Ivar Lange - Rune Svensli.....	Sunnmøre & Romsdal...	-47	4ØV
23.	24	Bjørn Løvås - Jan Norland.....	Rogaland.....	-51	1NS
24.	9	Thomas Bekkevold - Fredric Wilt.....	Oslo.....	-52	2ØV

C o l o r l i n e  
2 6 . a p r i l 1 9 9 6

S L U T T R E S U L T A T

1.	28	Finn Fyllingslid - Kurt Obstfelder.....	139	
2.	19	O.M. Jahren - J. Bjørgan.....	109	( 2
3.	13	Terje Sande - Svein Hamre.....	109	( 2
4.	32	Frode Fylling - Roger Træet.....	90	
5.	22	Erik Lunder - Tor Høiness.....	85	
6.	7	Geir Brekka - Trond Hantveit.....	73	
7.	43	Reidar Johnsen - Asbjørn Sjørnsen.....	62	
8.	5	Sam Inge Høyland - Ole Marius Myrvold....	51	
9.	8	Ove Andersbakken - Magne Håvard Forberg.	49	
10.	41	Kristien Breivik - Tore Brekke.....	46	
11.	37	Boye Brogeland - Yyvind saur.....	44	
12.	3	Jim Høyland - Sven Olai Høyland.....	43	
	6	Leif Gunnar Kleppevik - Karstein Kleppev k.....	43	
14.	25	Svein Th. Stedding - Birger Moen.....	39	
15.	2	Jarle Flått - Mathias Mediå.....	38	
16.	27	Ann-Mari Mirkovic - Bjørn Fjellstad.....	32	
17.	29	Fredrik Dahl - Steinar Aaland.....	26	
18.	20	Arild Holdaas - Kjetil Bildal.....	20	
19.	12	Atle Sæterdal - Svein C. Johannessen....	12	
20.	11	Tore Mortensen - Arnstein Aurdal.....	10	
21.	18	Rune Erland - Norvald Kulild.....	9	
22.	30	Stian Sundklakk - Steinar Kyrkjebø.....	8	
23.	1	Are Akselsen - Haakon Aarø.....	5	
24.	24	Ottesen - Jensen.....	3	
25.	9	Magne Ludvigsen - Tor Bølum.....	2	
26.	15	Atle Stray - Kjell Magne Fagerbakke.....	-4	
27.	21	Iversen - Evjen.....	-9	
28.	31	Erik Sælensminde - Arild Rasmussen.....	-17	
29.	35	Per Halvorsen - Helge Toft.....	-19	
30.	39	John Helge Herland - Mariann yri.....	-28	
31.	23	Stensen - Varmo.....	-32	
32.	4	Fredrik Rødli - Ivar Spillum.....	-35	
33.	26	walk over.....	-45	
34.	40	Randi Sivertsen - reidun Legreid.....	-51	
35.	42	Per Hafnor - Birger Nytrøen.....	-54	
36.	14	Stein Atle Juvik - Torstein Rognved.....	-60	
37.	17	Liv Bugge - Marit Hjelmeland.....	-68	
38.	33	Ole Kvamme - Inge Aasen.....	-75	
39.	44	Jan Egil Caspersen - Bjørn Landsvik.....	-77	
40.	36	Jonassen - Solli Sjøthun.....	-82	
41.	10	B.I. Lange - R. Svensli.....	-87	
42.	38	Oddvar Simonsen - Hans Tollefsen.....	-102	
43.	16	Martin Terje Nikolaisen - Mikal Langaun.	-113	

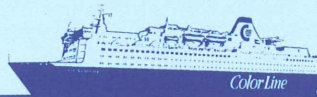

BERGEN • HAUGESUND • STAVANGER • NEWCASTLE

# INVITASJON

*Bergen Bridgekrets inviterer til COLOR CUP*

*i perioden*

*28. november - 1. desember 1996.*

*I samarbeid med Color Line inviterer Bergen Bridgekrets til bridgecruise med «M/S Color Viking» til Newcastle.*

*Hovedturneringen spilles som barometerturnering i tre sesjoner totalt 81 spill.*

*Kortere sideturneringer spilles som barometerturneringer etter behov.*

*Nybegynnerkurs i bridge.*

*Robberbridge.*

*Kombiner det nyttige med det behagelige.*

*Ta med familien på førjulshandel i Newcastle.*

*Nyt god mat-og drikke og tax-free priser ombord i M/S Color Viking.*

*Spill så mye bridge som du ønsker.*

*Julebord.*

*Priser fra kroner 1290,-*

*For påmelding ta kontakt med Bergen Bridgekrets.*



*Color Line*



# NM for Par 1996, Junior. 1. sesjon, runde 1

1 (1)      ♠ K 10 7 2  
 ♥ 10 7  
 ♦ 7 6 4 2  
 ♣ 10 6 5

♠ E D J 9 5  
 ♥ K J 9 3  
 ♦ D 8  
 ♣ 3 2

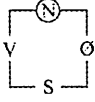

♠ 8 6 4 3  
 ♥ E  
 ♦ E K 9 5 3  
 ♣ E K 4

2 (2)      ♠ 9 6 3 2  
 ♥ E 8 6  
 ♦ 3 2  
 ♣ D J 8 3

♠ K D 10  
 ♥ 10 9 7 2  
 ♦ J 10 4  
 ♣ E 9 7

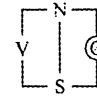

♠ J 7  
 ♥ D 5 3  
 ♦ E K D 9 5  
 ♣ 5 4 2

♠ E 8 5 4  
 ♥ K J 4  
 ♦ 8 7 6  
 ♣ K 10 6

NS	ØV	Kontrakt	NS+	ØV+	PNS	PØV	NS	ØV	Kontrakt	NS+	ØV+	PNS	PØV
23	2	4♠ x	N	10	590		11	-11					
16	9	5♥ x	Ø	8	500		9	-9					
18	7	3NT	N	9	400		7	-7					
8	17	4♥ x	Ø	8	300		3	-3					
12	13	4♥ x	Ø	8	300		3	-3					
15	10	4♥ x	Ø	8	300		3	-3					
20	5	4♥	Ø	8	100		-2	2					
24	1	4♥ x	V	9	100		-2	2					
11	14	3♥	Ø	8	50		-5	5					
6	19	4♠ x	S	9		100	-7	7					
21	4	3♥	Ø	9		140	-9	9					
22	3	5♠	N	7		200	-11	11					
22	3	2♠	N	8		110							
21	4	3♦	Ø	7		100							
20	5	Pass											
11	14	2♦	Ø	9		110							
16	9	3♦	Ø	9		110							
6	19	1NT	V	8		120	-4	4					
8	17	1NT	Ø	8		120	-4	4					
12	13	1NT	Ø	8		120	-4	4					
15	10	1NT	Ø	8		120	-4	4					
18	7	1NT	Ø	8		120	-4	4					
23	2	1NT	Ø	8		120	-4	4					
24	1	1NT	Ø	9		150	-11	11					

3 (3)      ♠ J 6  
 ♥ D J 5 2  
 ♦ E J 6  
 ♣ K D 7 6

♠ K 10 9 4 3  
 ♥ 10  
 ♦ 9 8 2  
 ♣ E J 10 8

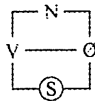

♠ E D 7 2  
 ♥ 9 8 6 4  
 ♦ 5 4  
 ♣ 9 5 3

4 (4)      ♠ D 9  
 ♥ E 7 6 4 2  
 ♦ 6 4  
 ♣ K J 4 2

♠ K J  
 ♥ K J 10 5  
 ♦ E 10 9 7 5  
 ♣ E 5

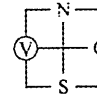

♠ 10 8 5 4 2  
 ♥ D  
 ♦ D J  
 ♣ D 10 9 8 7

♠ E 7 6 3  
 ♥ 9 8 3  
 ♦ K 8 3 2  
 ♣ 6 3

NS	ØV	Kontrakt	NS+	ØV+	PNS	PØV	NS	ØV	Kontrakt	NS+	ØV+	PNS	PØV
16	9	2NTx	Ø	4	1100		11	-11					
8	17	2♥	N	7		50	7	-7					
22	3	3♥	N	8		50	7	-7					
24	1	2♥	N	7		50	7	-7					
11	14	2♥	S	6		100	2	-2					
15	10	2♥	N	6		100	2	-2					
23	2	3♦	Ø	9		110	-1	1					
20	5	2♦	V	10		130	-3	3					
6	19	2♠	V	9		140	-5	5					
18	7	3♥ x	N	7		300	-7	7					
12	13	3♥ x	S	5		800	-9	9					
21	4	2♠ x	V	9		870	-11	11					
8	17	3NT	V	7		200							
12	13	3NT	V	7		200							
23	2	2♠	S	9		140							
22	3	2♣	N	8		90							
16	9	3♣	S	8		100	3	-3					
24	1	1NT	V	8		120	1	-1					
21	4	3♦	V	11		150	-1	1					
6	19	1NT	V	11		210	-4	4					
15	10	1NT	V	11		210	-4	4					
11	14	1NT	V	12		240	-7	7					
18	7	3NT	V	9		600	-10	10					
20	5	3NT	V	9		600	-10	10					

## NM for Par 1996, Junior. 1. sesjon, runde 2

5 (5)

♠ KD 6 2  
♥ EJ 8  
♦ D 6  
♣ K 10 4 2

♠ 8 5 3  
♥ K 9 7 5  
♦ 7 5  
♣ D 7 6 3

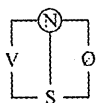

♠ 9 7  
♥ D 6 4  
♦ K J 10 4  
♣ EJ 8 5

♠ EJ 10 4  
♠ 10 3 2  
♠ E 9 8 3 2  
♠ 9

6 (6)

♠ J 10 6  
♥ KD 10 8 3  
♦ KD 10 4 3  
♣ -

♠ D 9 5  
♥ E 6  
♦ J 9 8 2  
♣ 9 8 7 2

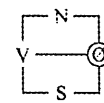

♠ K 2  
♥ J 5 4 2  
♦ 7 5  
♣ EKJ 6 5

♠ E 8 7 4 3  
♥ 9 7  
♦ E 6  
♣ D 10 4 3

NS	ØV	Kontrakt	NS+	ØV+	PNS	PØV	NS	ØV	Kontrakt	NS+	ØV+	PNS	PØV		
1	3	3NT	N	10	630	6	-6	16	11	4♥	N	11	450	9	-9
7	20	3NT	N	10	630	6	-6	19	8	4♥	S	11	450	9	-9
16	11	3NT	N	10	630	6	-6	23	4	4♥	N	11	450	9	-9
17	10	3NT	N	10	630	6	-6	1	3	4♥	N	10	420	-2	2
22	5	3NT	N	10	630	6	-6	7	20	4♥	N	10	420	-2	2
24	2	3NT	N	10	630	6	-6	9	18	4♥	N	10	420	-2	2
12	15	3NT	N	9	600	-4	4	12	15	4♥	S	10	420	-2	2
13	14	3NT	N	9	600	-4	4	13	14	4♥	N	10	420	-2	2
19	8	3NT	N	9	600	-4	4	17	10	4♥	N	10	420	-2	2
23	4	3NT	N	9	600	-4	4	21	6	4♥	N	10	420	-2	2
21	6	2♠ x	Ø	6	300	-9	9	22	5	4♥	N	10	420	-2	2
9	18	1NT	S	9	150	-11	11	24	2	3♠	Ø	7	200	-11	11

7 (7)

♠ E 9  
♥ D 6 5  
♦ EJ 8 6 5  
♣ J 9 6

♠ KD J 4 3  
♥ E 8 7  
♦ K 2  
♣ KD 8

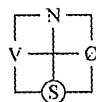

♠ 10 2  
♥ K J 9 4 2  
♦ 10 7 3  
♣ 10 3 2

♠ 8 7 6 5  
♠ 10 3  
♠ D 9 4  
♠ E 7 5 4

8 (8)

♠ 6 2  
♥ 10 9 7 4  
♦ KD J 5  
♣ E 10 4

♠ K J 8 5 4  
♥ -  
♦ E 9 6 3  
♣ J 8 5 3

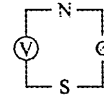

♠ E 9 3  
♥ E J 3  
♦ 10 7 2  
♣ D 9 6 2

♠ D 10 7  
♥ KD 8 6 5 2  
♦ 8 4  
♣ K 7

NS	ØV	Kontrakt	NS+	ØV+	PNS	PØV	NS	ØV	Kontrakt	NS+	ØV+	PNS	PØV		
16	11	3♠	V	10	170	11	-11	1	3	3♥	Ø	6	150	11	-11
17	10	3♠	V	11	200	9	-9	12	15	2♥	Ø	6	100	7	-7
1	3	4♠	V	10	620	0	0	16	11	2♠	V	6	100	7	-7
7	20	4♠	V	10	620	0	0	21	6	4♠	V	8	100	7	-7
12	15	4♠	V	10	620	0	0	24	2	2♠	V	7	50	3	-3
13	14	4♠	V	10	620	0	0	9	18	2♠	V	8	110	1	-1
21	6	4♠	V	10	620	0	0	7	20	2♠	V	9	140	-4	4
22	5	4♠	V	10	620	0	0	13	14	2♠	V	9	140	-4	4
23	4	4♠	V	10	620	0	0	22	5	2♠	V	9	140	-4	4
24	2	4♠	V	10	620	0	0	23	4	2♠	V	9	140	-4	4
9	18	4♠	V	11	650	-10	10	19	8	3♠	V	10	170	-9	9
19	8	4♠	V	11	650	-10	10	17	10	4♠	V	10	420	-11	11



## NM for Par 1996, Junior. 1. sesjon, runde 3

9 (9)  
 ♠ J 8  
 ♥ 9 3 2  
 ♦ E D 9 5 3  
 ♣ D 6 3

♠ D 5 4 3  
 ♥ E K 10  
 ♦ 10  
 ♣ J 10 7 4 2

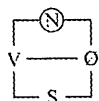

♠ E K 7  
 ♥ D J 8 7 6 4  
 ♦ K  
 ♣ E 9 5

♠ 10 9 6 2  
 ♠ 5  
 ♠ J 8 7 6 4 2  
 ♠ K 8

10 (10)  
 ♠ E 10 9 5 2  
 ♥ 3 2  
 ♦ 8 5 2  
 ♣ 9 8 3

♠ K 7 3  
 ♥ E K D 7  
 ♦ K D J  
 ♣ J 5 2

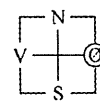

♠ D 8 6  
 ♥ 10 8 6  
 ♦ E 10 6 3  
 ♣ E K 4

♠ J 4  
 ♥ J 9 5 4  
 ♦ 9 7 4  
 ♣ D 10 7 6

NS	ØV	Kontrakt	NS+	ØV+	PNS	PØV	NS	ØV	Kontrakt	NS+	ØV+	PNS	PØV		
8	21	3♥	S	9	140		8	11	4♥	V	8	200	11	-11	
18	11	2♥	S	9	140		1	5	1NT	V	6	100	5	-5	
20	9	2♥	S	9	140		2	4	4♥	V	9	100	5	-5	
22	7	2♥	S	9	140		10	19	1NT	V	6	100	5	-5	
2	4	2♥	S	8	110		13	16	1NT	V	6	100	5	-5	
1	5	4♥	S	9		50	22	7	2NT	Ø	7	100	5	-5	
10	19	4♥	S	9		50	23	6	2♠	N	7		100	-1	1
14	15	4♥	S	9		50	8	21	2♣	Ø	9		110	-4	4
17	12	4♥	S	9		50	17	12	1♥	Ø	8		110	-4	4
23	6	3♦	N	8		50	24	3	1NT	V	8		120	-7	7
24	3	4♥	S	9		50	14	15	2♥	Ø	9		140	-9	9
13	16	4♥ x	S	9		100	20	9	2♠ x	N	7		200	-11	11

11 (11)  
 ♠ K D 6 3  
 ♥ 7 4 2  
 ♦ D 6 3  
 ♣ 7 6 5

♠ J 8  
 ♥ D J 10 9 5  
 ♦ E 10 4  
 ♣ E K 9

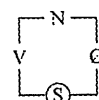

♠ E 10 9 2  
 ♥ E 3  
 ♦ K 8 7 2  
 ♣ D J 2

♠ 7 5 4  
 ♠ K 8 6  
 ♠ J 9 5  
 ♠ 10 8 4 3

12 (12)  
 ♠ 10 2  
 ♥ D 7 6 4 3  
 ♦ E 8 7 5 2  
 ♣ 5

♠ E K 8 7 6  
 ♥ K 8  
 ♦ K 10  
 ♣ 9 8 7 3

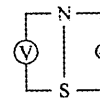

♠ 9 4  
 ♥ J 10 9 2  
 ♦ J 6 4  
 ♣ K 10 6 4

♠ D J 5 3  
 ♥ E 5  
 ♦ D 9 3  
 ♣ E D J 2

NS	ØV	Kontrakt	NS+	ØV+	PNS	PØV	NS	ØV	Kontrakt	NS+	ØV+	PNS	PØV		
10	19	2♠	N	8	110		2	4	6♠	V	10	100	11	-11	
17	12	2♠	N	8	110		13	16	6♠	V	11	50	8	-8	
18	11	1♠	S	8	110		14	15	6♠	V	11	50	8	-8	
20	9	2♠	S	8	110		10	19	4♠	V	10		420	3	-3
24	3	2♠	N	8	110		18	11	4♠	V	10		420	3	-3
2	4	3♥	V	8	50		22	7	4♠	V	10		420	3	-3
1	5	2♠	S	7		50	1	5	4♠	V	11		450	-6	6
13	16	2♠	S	7		50	8	21	4♠	V	11		450	-6	6
14	15	2♠	N	7		50	17	12	4♠	V	11		450	-6	6
23	6	2♠	S	7		50	20	9	4♠	V	11		450	-6	6
8	21	3♥	V	9		140	23	6	4♠	V	11		450	-6	6
22	7	3♥	V	10		170	24	3	4♠	V	11		450	-6	6

## NM for Par 1996, Junior. 1. sesjon, runde 4

13 (13)  
 ♠ E D J 7 4 3  
 ♥ K J 9  
 ♦ 6  
 ♣ 10 8 6

♠ 10 8 2  
 ♥ D 7 3 2  
 ♦ J 8 4  
 ♣ E 7 2

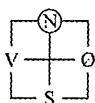

♠ 5  
 ♥ E 10 6 4  
 ♦ E K 10 7 5  
 ♣ 9 4 3

♠ K 9 6  
 ♥ 8 5  
 ♦ D 9 3 2  
 ♣ K D J 5

14 (14)  
 ♠ E D 2  
 ♥ D 9 8 6  
 ♦ 10 9  
 ♣ K 10 4 3

♠ 9 6  
 ♥ E J 7  
 ♦ E K J 3  
 ♣ E D 9 8

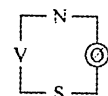

♠ J 10 7 5 4  
 ♥ K 5 3  
 ♦ D 8 6 4 2  
 ♣ -

♠ K 8 3  
 ♥ 10 4 2  
 ♦ 7 5  
 ♣ J 7 6 5 2

NS	ØV	Kontrakt	NS+	ØV+	PNS	PØV	NS	ØV	Kontrakt	NS+	ØV+	PNS	PØV
3	5	4♠ x N	10	790	11	-11	2	6	6♦ Ø	11	50	10	-10
23	8	4♠ N	10	620	9	-9	21	10	6♦ V	11	50	10	-10
18	13	3♦ x V	7	500	7	-7	1	7	3NT V	9	400	3	-3
1	7	2♠ N	10	170	0	0	3	5	5♦ V	11	400	3	-3
9	22	3♠ N	10	170	0	0	9	22	3NT V	9	400	3	-3
11	20	3♠ N	10	170	0	0	18	13	3NT V	9	400	3	-3
15	16	3♠ N	10	170	0	0	19	12	5♦ Ø	11	400	3	-3
21	10	3♠ N	10	170	0	0	24	4	4♠ Ø	10	420	-3	3
24	4	3♠ N	10	170	0	0	11	20	3NT V	10	430	-6	6
14	17	2♠ N	9	140	-7	7	15	16	3NT V	10	430	-6	6
2	6	4♠ N	9	100	-9	9	14	17	3NT V	11	460	-10	10
19	12	4♠ N	8	200	-11	11	23	8	3NT V	11	460	-10	10

15 (15)  
 ♠ K D 9 6 2  
 ♥ D 8  
 ♦ E D 5 4 3  
 ♣ 2

♠ J  
 ♥ K 3  
 ♦ 7 6  
 ♣ E K 10 8 7 6 4 3



♠ 8 5  
 ♥ E J 10 9 7 5  
 ♦ 10 9 8 2  
 ♣ D

♠ E 10 7 4 3  
 ♥ 6 4 2  
 ♦ K J  
 ♣ J 9 5

16 (16)  
 ♠ E 6 4  
 ♥ E 8 6  
 ♦ K J 9 5  
 ♣ K D 6

♠ D J 10 7  
 ♥ D J 7 3  
 ♦ E 10  
 ♣ E 8 5

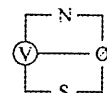

♠ 8 3 2  
 ♥ 4 2  
 ♦ D 8 6 4 2  
 ♣ J 10 3

♠ K 9 5  
 ♥ K 10 9 5  
 ♦ 7 3  
 ♣ 9 7 4 2

NS	ØV	Kontrakt	NS+	ØV+	PNS	PØV	NS	ØV	Kontrakt	NS+	ØV+	PNS	PØV
3	5	4♠ x N	12	1190	11	-11	11	20	2♥ S	9	140	11	-11
19	12	4♠ S	12	680	9	-9	3	5	1NT N	8	120	7	-7
24	4	5♥ x Ø	8	500	7	-7	14	17	1NT N	8	120	7	-7
11	20	3♠ N	12	230	5	-5	18	13	1NT N	8	120	7	-7
1	7	3NT V	5	200	3	-3	1	7	1NT N	7	90	-1	1
23	8	5♣ V	10	50	1	-1	9	22	1NT N	7	90	-1	1
15	16	5♠ N	10	100	-1	1	15	16	1NT N	7	90	-1	1
18	13	4♣ V	13	190	-3	3	21	10	1NT N	7	90	-1	1
9	22	5♣ V	12	420	-5	5	24	4	1NT N	7	90	-1	1
14	17	5♣ x V	11	550	-7	7	19	12	3♥ S	8	50	-8	8
2	6	5♣ x Ø	12	650	-9	9	23	8	1NT N	6	50	-8	8
21	10	5♣ x V	13	750	-11	11	2	6	3NT N	6	150	-11	11

# NM for Par 1996, Junior. 1. sesjon, runde 5

17 (17)

♠ 10 4 3 2  
♥ E K 4  
♦ -  
♣ D 7 6 5 4 3

♠ 7  
♥ J 9 5  
♦ E D J 8 6 4  
♣ E J 9

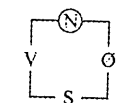

♠ E K J  
♥ 8 6 2  
♦ 10 5 3 2  
♣ 10 8 2

♠ D 9 8 6 5  
♥ D 10 7 3  
♦ K 9 7  
♣ K

18 (18)

♠ D 8 6 4  
♥ K D 9 5 3  
♦ 7 2  
♣ E 6

♠ E 9  
♥ E J 10  
♦ J 6 5  
♣ K D 10 9 4

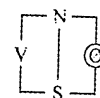

♠ 10 5 2  
♥ 8 7 4  
♦ K 4  
♣ J 8 7 5 2

♠ K J 7 3  
♥ 6 2  
♦ E D 10 9 8 3  
♣ 3

NS	ØV	Kontrakt		NS+	ØV+	PNS	PØV
1	9	2♠	Ø	7	50	8	-8
4	6	3NT	V	8	50	8	-8
10	23	3NT	V	8	50	8	-8
16	17	3NT	Ø	8	50	8	-8
2	8	4♣ x	N	9	100	2	-2
22	11	4♣ x	N	9	100	2	-2
12	21	3♦	Ø	10	130	-3	3
15	18	3♦	Ø	10	130	-3	3
19	14	3♦	V	10	130	-3	3
24	5	3NT	V	9	400	-7	7
20	13	3NT	V	11	460	-9	9
3	7	3NTx	V	9	550	-11	11

NS	ØV	Kontrakt		NS+	ØV+	PNS	PØV
24	5	2♥ x	N	7	200	11	-11
19	14	3NT	V	9	400	9	-9
2	8	3NT	V	10	430	3	-3
3	7	3NT	V	10	430	3	-3
15	18	3NT	V	10	430	3	-3
16	17	3NT	V	10	430	3	-3
22	11	3NT	V	10	430	3	-3
4	6	3NT	V	11	460	-6	6
10	23	3NT	V	11	460	-6	6
12	21	3NT	V	11	460	-6	6
20	13	3NT	V	11	460	-6	6
1	9	2♥ x	N	5	800	-11	11

19 (19)

♠ J 2  
♥ D 8 7 5  
♦ E D 8 6 4  
♣ 10 2

♠ K 9 7 3  
♥ 10 6 2  
♦ 10  
♣ K 8 7 5 4

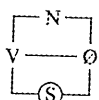

♠ 10 6 4  
♥ K J 9 4  
♦ K 9 7 2  
♣ E D

♠ E D 8 5  
♥ E 3  
♦ J 5 3  
♣ J 9 6 3

20 (20)

♠ D 10 4  
♥ 7 4  
♦ E D 7 4  
♣ E K D 7

♠ 2  
♥ E 10 8 6  
♦ J 10 9 5  
♣ J 10 5 4

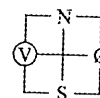

♠ E 9 8 5 3  
♥ J 9 5 2  
♦ 6  
♣ 8 3 2

♠ K J 7 6  
♥ K D 3  
♦ K 8 3 2  
♣ 9 6

NS	ØV	Kontrakt		NS+	ØV+	PNS	PØV
20	13	3NT	S	10	430	11	-11
1	9	3♥	N	10	170	7	-7
12	21	2♥	S	10	170	7	-7
16	17	3♥	N	10	170	7	-7
4	6	3♥	N	9	140	3	-3
19	14	1NT	S	8	120	1	-1
22	11	2♦	S	9	110	-1	1
10	23	4♥	N	9	50	-4	4
24	5	4♥	N	9	50	-4	4
2	8	4♥	S	8	100	-7	7
15	18	4♥	N	7	150	-9	9
3	7	3♠	V	10	170	-11	11

NS	ØV	Kontrakt		NS+	ØV+	PNS	PØV
2	8	2♠	N	9	140	8	-8
3	7	2♠	S	9	140	8	-8
10	23	3♠	S	9	140	8	-8
16	17	2♠	S	9	140	8	-8
4	6	1NT	N	8	120	2	-2
19	14	2NT	N	8	120	2	-2
12	21	2♠	N	8	110	-3	3
15	18	2♠	N	8	110	-3	3
20	13	2♠	N	8	110	-3	3
1	9	3♠	S	8	100	-8	8
24	5	2♠	N	7	100	-8	8
22	11	4♠	N	8	200	-11	11

# NM for Par 1996, Junior. 1. sesjon, runde 6

21 (21)      ♠ E D 6 4 3

♥ 4  
♦ E J 7 6  
♣ K 10 9

♠ 10 8  
♥ E 8 6 5 3  
♦ 5 2  
♣ E D J 7

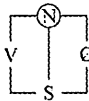

♠ J 7 5  
♥ K J  
♦ K D 10 4 3  
♣ 8 5 2

♠ K 9 2  
♥ D 10 9 7 2  
♦ 9 8  
♣ 6 4 3

22 (22)

♠ E K D 9 7

♥ -  
♦ D 7 6 4  
♣ E K 10 2

♠ 6 4 3  
♥ E D 10 9 8 5 3  
♦ 8 3  
♣ 7

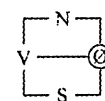

♠ 8  
♥ J 2  
♦ E K J 10 5 2  
♣ D 9 6 4

♠ J 10 5 2  
♥ K 7 6 4  
♦ 9  
♣ J 8 5 3

NS	ØV	Kontrakt	NS+	ØV+	PNS	PØV	NS	ØV	Kontrakt	NS+	ØV+	PNS	PØV
4	8	4♠ N	11	650	11	-11	2	10	7♦ S	13	1440	5	-5
2	10	4♠ N	10	620	3	-3	5	7	7♦ S	13	1440	5	-5
3	9	4♠ N	10	620	3	-3	13	22	7♦ S	13	1440	5	-5
11	1	4♠ N	10	620	3	-3	16	19	7♦ S	13	1440	5	-5
17	18	4♠ N	10	620	3	-3	17	18	7♦ S	13	1440	5	-5
20	15	4♠ N	10	620	3	-3	21	14	7♦ S	13	1440	5	-5
21	14	4♠ N	10	620	3	-3	23	12	7♦ S	13	1440	5	-5
23	12	4♠ N	10	620	3	-3	3	9	6♦ S	13	940	-4	4
13	22	5♥ x V	8	500	-6	6	11	1	6♣ N	13	940	-4	4
24	6	5♥ x Ø	8	500	-6	6	4	8	4♠ N	12	480	-8	8
16	19	2♠ N	10	170	-9	9	24	6	4♠ N	12	480	-8	8
5	7	5♦ S	9	200	-11	11	20	15	3♥ x V	8	200	-11	11

23 (23)

♠ E 9 5  
♥ E 9 3  
♦ E D 9 8 4  
♣ J 2

♠ K 6  
♥ 8  
♦ 7 6 2  
♣ E D 9 6 5 4 3

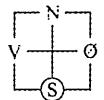

♠ J 10 8 7 4 2  
♥ D 4  
♦ K J 10 5  
♣ 7

♠ D 3  
♥ K J 10 7 6 5 2  
♦ 3  
♣ K 10 8

24 (24)

♠ K 8 2  
♥ 5 3  
♦ E D 9 7 4  
♣ D 10 4

♠ J 10  
♥ K D 10 6  
♦ 6 3 2  
♣ K 8 7 2

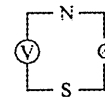

♠ E D 9 3  
♥ J 8 2  
♦ J 10 8  
♣ J 6 5

♠ 7 6 5 4  
♥ E 9 7 4  
♦ K 5  
♣ E 9 3

NS	ØV	Kontrakt	NS+	ØV+	PNS	PØV	NS	ØV	Kontrakt	NS+	ØV+	PNS	PØV
21	14	4♥ x Ø	8	500	11	-11	23	12	2♠ S	8	110	10	-10
4	8	3NT V	6	300	9	-9	24	6	2♠ S	8	110	10	-10
3	9	5♣ x V	10	200	4	-4	20	15	1NT N	7	90	7	-7
5	7	5♣ x V	10	200	4	-4	4	8	4♥ V	9	50	5	-5
13	22	5♣ x V	10	200	4	-4	2	10	2♥ V	9	140	-3	3
23	12	4♥ x V	9	200	4	-4	3	9	3♥ V	9	140	-3	3
11	1	3♠ S	9	140	-1	1	5	7	3♥ Ø	9	140	-3	3
16	19	4♠ S	9	100	-5	5	11	1	2♥ Ø	9	140	-3	3
17	18	4♠ S	9	100	-5	5	13	22	3♥ V	9	140	-3	3
20	15	3♠ S	8	100	-5	5	17	18	2♥ V	9	140	-3	3
2	10	4♠ x S	9	200	-9	9	21	14	3♥ Ø	9	140	-3	3
24	6	3♣ x V	12	1270	-11	11	16	19	2♥ x V	8	470	-11	11

## NM for Par 1996, Junior. 1. sesjon, runde 7

25 (25)

♠ E 8 7 6  
♥ J 9 6  
♦ D 9 8 7  
♣ K 2

♠ 5 3  
♥ D 4 2  
♦ 3 2  
♣ E D 10 8 4 3



♠ K D 10 9  
♥ K 10 8 7  
♦ K J 10 4  
♣ 5

♠ J 4 2  
♥ E 5 3  
♦ E 6 5  
♣ J 9 7 6

26 (26)

♠ D J 10 8 6 4  
♥ D 5  
♦ K 10 7  
♣ 8 4

♠ E K  
♥ E K J 8 2  
♦ 6 4 3  
♣ 9 7 5

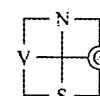

♠ 5 3 2  
♥ 10 9 7 6 3  
♦ E J 9 8  
♣ J

♠ 9 7  
♥ 4  
♦ D 5 2  
♣ E K D 10 6 3 2

NS	ØV	Kontrakt	NS+	ØV+	PNS	PØV	NS	ØV	Kontrakt	NS+	ØV+	PNS	PØV		
1	13	2♠	N	9	140	6	-6	14	23	6NT	Ø	8	400	11	-11
4	10	2♠	N	9	140	6	-6	6	8	3♠	N	11	200	8	-8
5	9	3♠	N	9	140	6	-6	22	15	6♣	Ø	10	200	8	-8
12	2	3♠	S	9	140	6	-6	4	10	6♣	Ø	11	100	4	-4
21	16	2♠	N	9	140	6	-6	24	7	6♣	Ø	11	100	4	-4
22	15	2♠	N	9	140	6	-6	12	2	3♣	Ø	9	110	1	-1
14	23	3♦	S	9	110	-3	3	18	19	4♣	V	13	190	-1	1
17	20	3♦	S	9	110	-3	3	1	13	3NT	Ø	11	660	-3	3
18	19	3♦	S	9	110	-3	3	3	11	3NT	V	12	690	-6	6
3	11	4♠	N	9	50	-9	9	5	9	3NT	Ø	12	690	-6	6
6	8	3♥	S	8	50	-9	9	17	20	3NT	Ø	13	720	-9	9
24	7	4♠	N	9	50	-9	9	21	16	6♣	V	13	1390	-11	11

27 (27)

♠ E 8 7 5  
♥ E 8 5  
♦ J 7 2  
♣ D 6 4

♠ D 10 3  
♥ J 2  
♦ E D 8 6 5  
♣ K 7 5



♠ K  
♥ K D 10 7 4  
♦ K 10 4  
♣ E 10 8 3

♠ J 9 6 4 2  
♥ 9 6 3  
♦ 9 3  
♣ J 9 2

28 (28)

♠ D 9 6  
♥ D J 9 5  
♦ K D 4 3  
♣ K J

♠ 10 7 3  
♥ K 6 4 2  
♦ 9 6  
♣ E D 8 3



♠ E J 8 5 4  
♥ 10  
♦ J 10 8 5 2  
♣ 9 6

♠ K 2  
♥ E 8 7 3  
♦ E 7  
♣ 10 7 5 4 2

NS	ØV	Kontrakt	NS+	ØV+	PNS	PØV	NS	ØV	Kontrakt	NS+	ØV+	PNS	PØV		
4	10	3NT	S	11	460	11	-11	5	9	3♥ x	V	7	300	11	-11
17	20	4♥	S	11	450	8	-8	21	16	3♥	Ø	4	250	9	-9
18	19	4♥	S	11	450	8	-8	1	13	3♠	S	10	170	5	-5
3	11	4♥	S	10	420	1	-1	3	11	2♠	S	10	170	5	-5
6	8	4♥	S	10	420	1	-1	12	2	2♠	S	10	170	5	-5
12	2	4♥	S	10	420	1	-1	18	19	3♥	V	6	150	1	-1
14	23	4♥	S	10	420	1	-1	6	8	3♠	S	9	140	-2	2
24	7	4♥	S	10	420	1	-1	14	23	3♠	S	9	140	-2	2
5	9	3♥	S	11	200	-5	5	4	10	3♦	N	10	130	-6	6
1	13	3♥	S	10	170	-8	8	17	20	2♦	N	10	130	-6	6
22	15	2♥	S	10	170	-8	8	22	15	3♠	S	8	100	-10	10
21	16	3♥	S	9	140	-11	11	24	7	4♠	S	9	100	-10	10

